



# Model DF10012H

100AH 12V  
LiFePO<sub>4</sub> Deep Cycle Battery  
Data sheet

Electrical Specification	
Voltage	12V
Capacity	100AH
Operating Temperature	- 4°F (-20°C) to 135°F (57.2°C)
Efficiency	99%
Self Discharge	2-3% per month
Maximum Series Voltage	48V
Cycles	3K-5K
Built-in BMS	Internal
Resistance	12 mΩ
Usable DoD	100%

Charging Specification	
Recommended Charge Current	.5c
Max Charge Current	50A
Absorption Voltage	14.2V-14.6V
Float Voltage	13.4V-13.8V
Equalization Voltage (if applicable)	14.4V
Absorption Time	30 Minutes per 100AH battery bank
BMS Charge Current Cut-Off	.5C Recommended
Recharge/Rebulk Voltage	13.3V
BMS Cell Balancing Voltage Range	14.2V-14.6V
High BMS Voltage Protection	14.7VDC
Temperature Compensation	No/Disable

Discharging Specification	
Max Discharge Current	100A
Peak Discharge Current	200A for 30 Seconds
Surge for Loads over 500A	.5 Seconds
Recommended LVD	10.5V
BMS Discharge Voltage Cut-Off	10V
Reconnect Voltage	10V
Short Circuit Protection	Yes

Mechanical Specification	
Dimensions	12.76" L X 6.86" W X 8.95" H
Weight	31 lbs.
Terminal Type	.25" Brass
Terminal Hole	3/8" hole and 3/8" or 5/16" hardware is suggested
Terminal Torque	9-11 Ft-lb.
Case Material	ABS Fire Rated
Cell Type - Electrolyte	LiFePO <sub>4</sub>
Sealed and Water Resistant Case	Non-Submersible
Heat	Proprietary Internal Heating Solution
Heat Enable Terminal	Female M4 Thread

Recognized Specification	
Certifications	UN38.3, UL/CSA-62133-2, UL-2054
Shipping Class	UN3480, Class 9

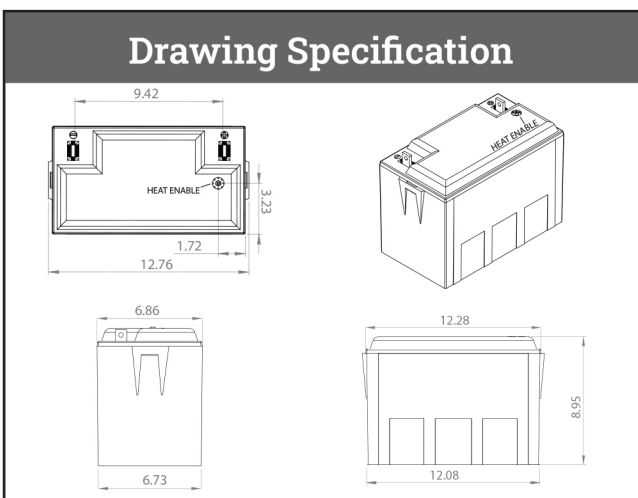

Temperature Specification	
Discharge Temperature	-4°F to 135°F (-20°C to 57.2°C)
Charge Temperature	25°F - 135°F
Storage Temperature	-10°F to 140°F (-23°C to 60°C)
BMS High Temperature Cut-Off	>135°F
BMS Reconnect Temperature	<135°F



## Performed Operation Data

**.5C Discharge with Temperature Variations**

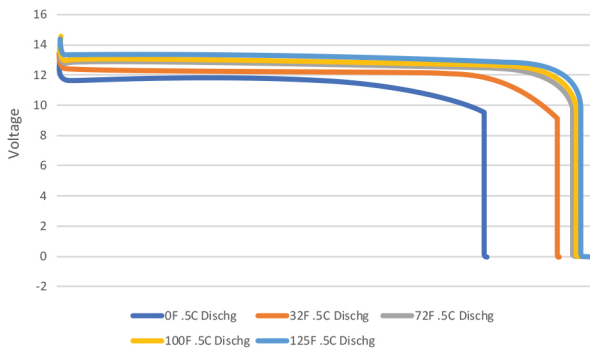

**1C Discharge Voltage with Temperature Variations**

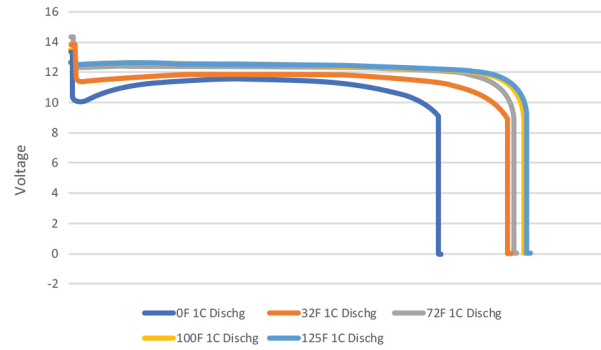

**.5C State of Charge with Temperature Variations**

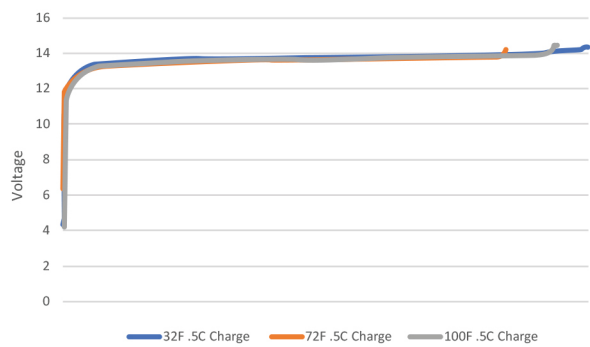

**Standard Charge Curve with 3 Stage Charger**

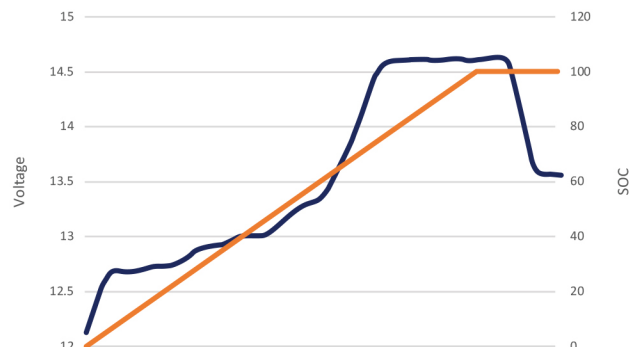

**10012 Heater Draw Expected in a 24Hr Period**

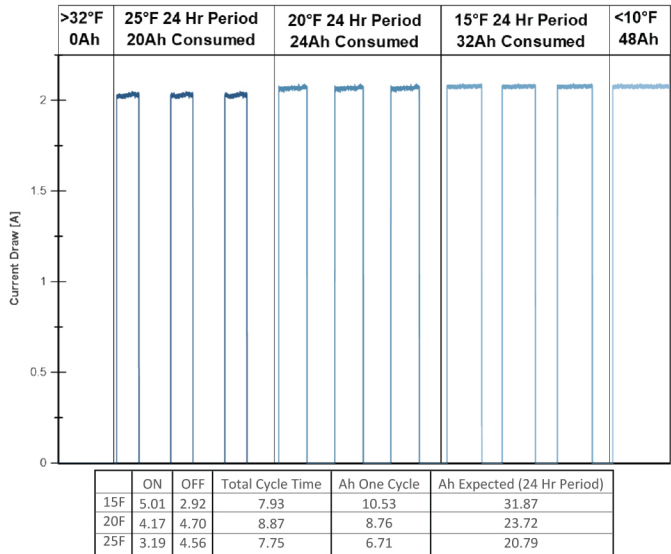
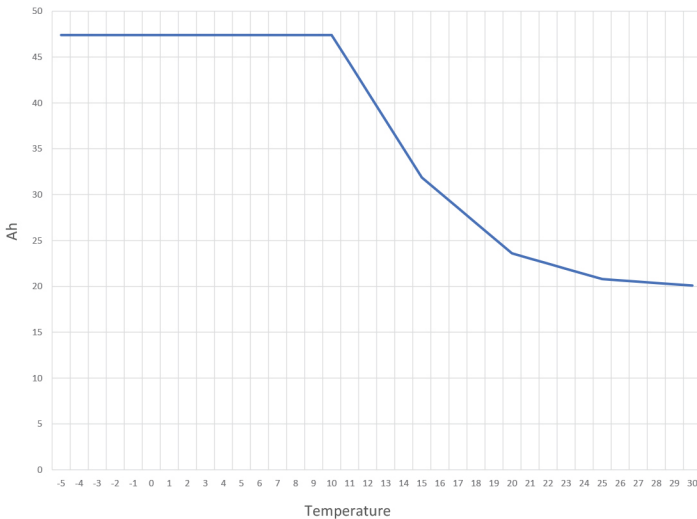

\*Note: The storage temperature range is -10°F to 140°F (-23°C to 60°C). We recommend bringing the Dragonfly Energy Batteries to a 100% charge and then disconnecting them completely for storage. After six months in storage, your batteries will remain 75 - 80% charged.

Storing batteries in subzero weather (-15°F or more) has the potential to crack the ABS plastic and more importantly could cause a faster loss of capacity, in some cases drastically more than the typical 2 - 4% per month loss.